

# C-SERIES C3000E-C5000E

The electric multi-directional forklift designed for the safe, space saving and productive handling of long and bulky loads.

# COMBiLiFT

LIFTING INNOVATION



# C-SERIES

## C3000E-C5000E

### FRONTAL MODE

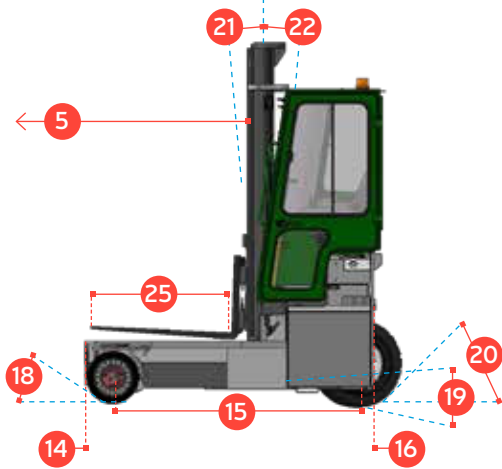

### SIWARD MODE

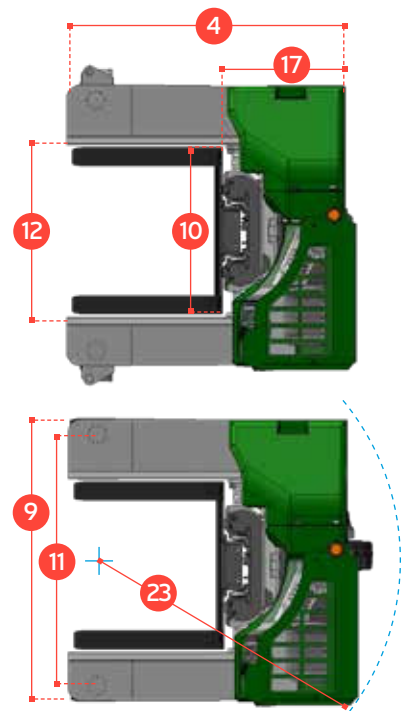
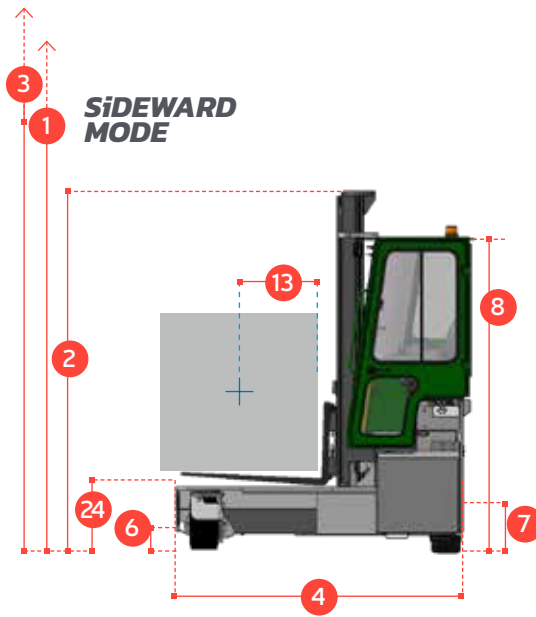

REF.	DESCRIPTION	C3000 E	C4000 E	C5000 E
1a	Max. Lift Height		4040mm	
1b	Freelift Height		0mm	
2	Height Mast Closed		2855mm	
3	Max. (Mast raised)		4870mm	
4	Overall Length	1950mm	2300mm	2500mm
5	Mast Travel	950mm	1300mm	1450mm
6	Ground Clearance Under Mast		150mm	
7	Ground Clearance to Centre of Wheelbase		310mm	
8	Height Over Cab (Without work lights)		2440mm	
9	Width		2275mm	
10	Outside Spread of Fork Arms		1350mm	
11	Track Front		2025mm	
12	Frame Opening		1400mm	
13	Load Centre Distance	450mm	600mm	600mm
14	Overhang Front		220mm	
15	Wheelbase	1545mm	1895mm	2045mm
16	Overhang Back		135mm	
17	Length From Face of Fork	1100mm	1100mm	1150mm
18	Approach Angle		45°	
19	Ramp Angle		17°	
20	Departure Angle		45°	
21	Forward Tilt		3°	
22	Backward Tilt		5°	
23	Minimum Outside Radius	2235mm	2310mm	2490mm
24	Platform Height		485mm	
25	Platform Length	850mm	1200mm	1350mm
A	Capacity	3000kg	4000kg	5000kg
B	Unladen Weight	6300kg	6650kg	6850kg
C	Maximum Ground Speed	10km/h		
D	Gradeability	10%		
E	Battery Capacity ( V / Ah)	80V / 620Ah		
F	Fork Section	50mm x 150mm x 850mm	50mm x 150mm x 1200mm	50mm x 150mm x 1350mm
G	405x305x220 Front Tyre (Solid Rubber)	OD 406mm / Width 220mm		
H	27 x 10-12 Rear Tyre	OD 680mm / Width 255mm		
I	Standard Colour	Green & Grey		
J	AC Electric Traction Motor x 2	80v / 5kW		
K	AC Electric Pump Motor	80V / 19kW		

### Multi-Directional



### Features Include:

- Rubber Mounted Cabin
- AC Motor Technology
- Multi-Direction Operation
- Load Sensing Steering
- Curtis AC Software
- 4 Way Lever Positioning of Wheels
- 2 Wheel Drive

### Distributed by:

International Patent Application No. PCT/EP2014/053066; UK Patent Application No. GB 1302811.3

COMBILIFT HAS A POLICY OF CONTINUOUS PRODUCT DEVELOPMENT AND RESERVES THE RIGHT TO ALTER SPECIFICATIONS WITHOUT PRIOR NOTICE. SPECIFICATIONS AND/OR DIMENSIONS MAY VARY FROM THOSE ILLUSTRATED IN SOME COUNTRIES.