

COMBi-CB4

The innovative and compact Combi-CB is designed to increase productivity, improve safety and help increase your storage capacity both indoors & outdoors.

COMBiLiFT

LIFTING INNOVATION



COMBi-CB4

FRONTAL MODE

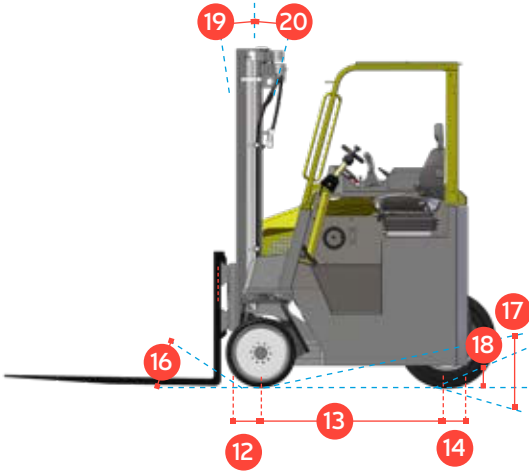

SIWARD MODE

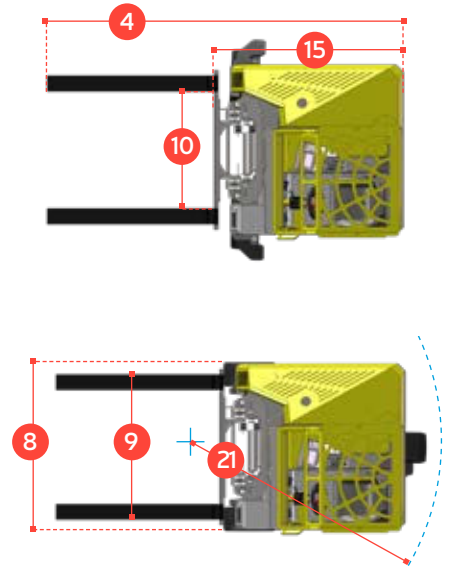
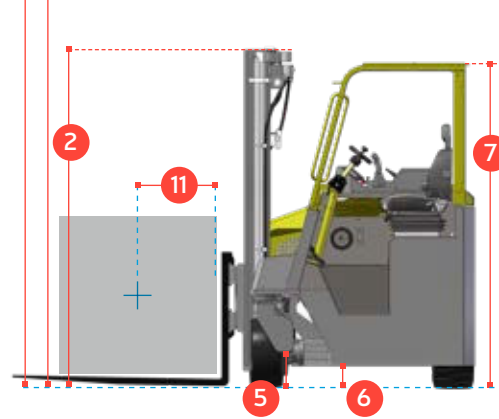

REF.	DESCRIPTION	STANDARD
1 a	Max. Lift Height	4040mm
1 b	Free Lift Height	0mm
2	Height Mast Closed	2900mm
3	Max. (Mast raised)	5050mm
4	Overall Length	2905mm
5	Ground Clearance Under Mast	152mm
6	Ground Clearance to Wheelbase Centre	152mm
7	Height of Overhead Guard	2356mm
8	Width	1624mm
9	Outside Spread of Fork Arms	1500mm
10	Track Front	1395mm
11	Load Centre Distance	600mm
12	Overhang Front	340mm
13	Wheel Base	1350mm
14	Overhang Back	165mm
15	Length From Face of Fork	1840mm
16	Approach Angle	30°
17	Ramp Angle	28°
18	Departure Angle	30°
19	Forward Tilt	3°
20	Backward Tilt	5°
21	Minimum Outside Radius	1685mm
A	Capacity	4000 kg
B	Unladen Weight	8650 kg
C	Maximum Ground Speed	13 Km/h
D	Gradeability	10%
E	Kubota V2403-T diesel / 3ltr GM LPG	44KW / 48KW
F	Electrics	12 Volt
G	Fork Section	150mm x 50mm x 1065mm
H	20 x 9 x 15 Front Tyre x 2 (Solid Rubber)	OD 533mm / Width 229mm
I	28 x 12.5 – 15 Rear Tyre x 1 (Super Elastic)	OD 711mm / Width 318mm
J	Standard Colour	Green and Grey
K	Suspension Seat	KAB Model 116

Multi-Directional

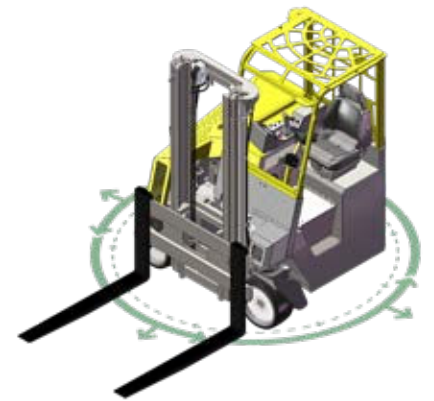

Features Include:

- Open Cabin
- Multi-Direction Operation
- Load Sensing Steering
- 3 Wheel Hydrostatic Drive
- 4-way lever positioning of Wheels

Distributed by:

Protected by Design Registration Copyright: European Community No.: 000725668-0001; US No.: D579, 624; Canadian No.: 123292b | Australian No.: 318370; Russian Federation No.: 70814 | Korean No.: 30-0516087; Japanese No.: 1330896; Taiwan No.: D126056; Chinese No.: ZL200730329732.6

COMBILIFT HAS A POLICY OF CONTINUOUS PRODUCT DEVELOPMENT AND RESERVES THE RIGHT TO ALTER SPECIFICATIONS WITHOUT PRIOR NOTICE. SPECIFICATIONS AND/OR DIMENSIONS MAY VARY FROM THOSE ILLUSTRATED IN SOME COUNTRIES.