

COMBi-CBE

The innovative Combi-CBE is designed to increase productivity, improve safety and help increase your storage capacity both indoors & outdoors.

COMBiLiFT

LIFTING INNOVATION



combilift.com

COMBi-CBE

FRONTAL MODE

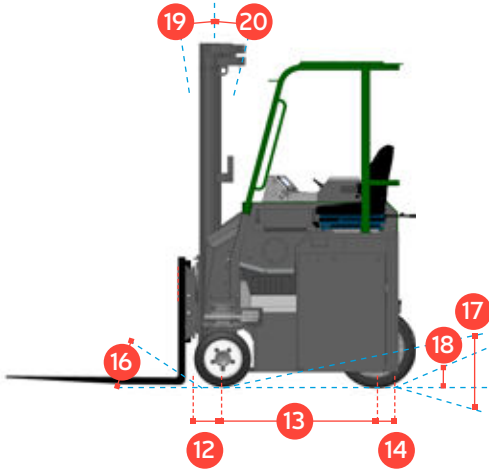

SIWARD MODE

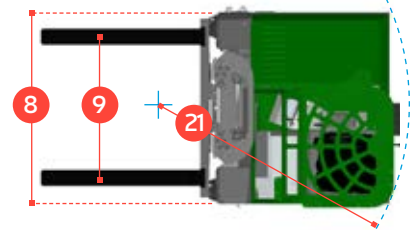
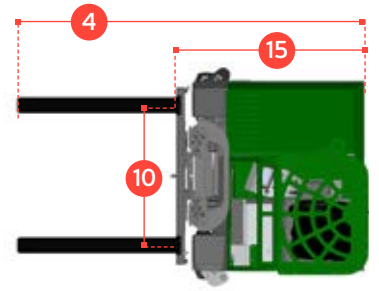
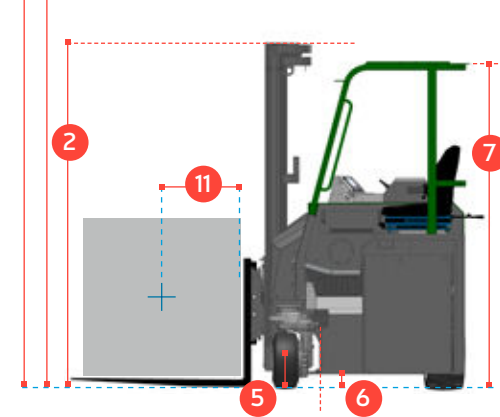

REF.	DESCRIPTION	STD.	OPTION
1 a	Standard Lift Height	4000mm	4900mm 5500mm 6000mm
1 b	Free Lift Height	0mm	1318mm 1518mm 1683mm
2	Height Mast Closed	2670mm	2243mm 2443mm 2610mm
3	Max. (Mast raised)	4850mm	5778mm 6378mm 6878mm
4	Overall Length	2565mm / 2695mm	
5	Ground Clearance Under Mast	125mm	
6	Ground Clearance to Wheelbase Centre	100mm	
7	Height of Overhead Guard	2250mm	
8	Width	1500mm	
9	Outside Spread of Fork Arms	1325mm	
10	Track Front	1320mm	
11	Load Centre Distance	600mm	
12	Overhang Front	300mm	
13	Wheelbase	1070mm	
14	Overhang Back	150 / 130 mm	
15	Length From Face of Fork	1550mm / 1580mm	
16	Approach Angle	30°	
17	Ramp Angle	15°	
18	Departure Angle	30°	
19	Forward Tilt	3°	
20	Backward Tilt	5°	
21	Minimum Outside Radius	1400mm	
A	Capacity	2500 kg / 3000 kg	
B	Unladen Weight	6500 kg / 6800 kg	
C	Maximum Ground Speed	11 km/h	
D	Gradeability	10%	
E	Battery Capacity	48 V / 930 Ah	
F	AC Electric Traction Motor x 2	48 V / 5 kW	
G	AC Electric Pump Motor	48 V / 14 kW	
H	Fork Section	125mm x 50mm x 1065mm	
I	16 x 7 – 10.5 Front Tyre x 2	OD 406mm / Width 178mm	
J	22 x 10 x 16 Rear Tyre x 1	OD 559mm / Width 254mm	
K	Standard Colour	Green and Grey	
L	Suspension Seat	Grammer MSG 65	

rev. 1.1

Multi-Directional



Features Include:

- +/- 100mm side shift
- Load sensing steering
- 4-Way lever positioning of wheels
- System Communication via CAN-BUS
- Multi-directional operation
- 2 Wheel Electric Drive
- Powered by AC Technology

Distributed by:

Protected by Design Registration Copyright: European Community No.: 000725668-0001|US No.: D579, 624| Canadian No.: 123292|Australian No.: 318370| Russian Federation No.: 70814 |Korean No.: 30-0516087| Japanese No.: 1330896|Taiwan No.: D126056| Chinese No.: ZL200730329732.6

COMBILIFT HAS A POLICY OF CONTINUOUS PRODUCT DEVELOPMENT AND RESERVES THE RIGHT TO ALTER SPECIFICATIONS WITHOUT PRIOR NOTICE. SPECIFICATIONS AND/OR DIMENSIONS MAY VARY FROM THOSE ILLUSTRATED IN SOME COUNTRIES.